



Tender Number: 6000017196

India Security Press,
(A UNIT OF SECURITY PRINTING & MINTING CORPORATION OF INDIA
LTD.) WHOLLY OWNED BY GOVERNMENT OF INDIA
Nashik Road-422101 (Maharashtra)
(ISO-9001:2008 & 14001:2004 Certified Company)
Miniratna Category-I, CPSE
Tel.No:+91-253-2-402200; Fax No:+91-253-2462718,2466389
e-mail: purchase.isp@spmcl.com Web:http://ispnasik.spmcl.com
CIN: U22213DL2006GOI144763 GSTIN: 27AAJCS6111J2Z7

PR Number	PR Date	Indenter	Department
10027970	31.12.2021	DCS	CSD

Not Transferable

Security Classification:

**TENDER DOCUMENT FOR PURCHASE OF: CORRUGATED BOXES IN THE SIZE OF
530 MM (L) X 400 MM (W) X 300 MM (H)**

Tender Number: 6000017196/113/SY-3-14(XF)2021-22, Dated: 10.02.2022

This Tender Document Contains _____ Pages.

Details of Contact person in SPMCIL regarding this tender:

Name: ASHOK SHARMA
Designation: Jt. General Manager (Materials)
Address: ISPN (India Security Press, Nashik) India



Tender Number: 6000017196

Disclaimer

The information contained in this Bid Document or subsequently provided to Bidder(s), whether verbally or in documentary or any other form by or on behalf of the Security Printing and Minting Corporation Limited (hereafter referred as the "Purchaser") or any of its employees or associated agencies, is provided to Bidder(s) on the terms and conditions set out in this Bid Document and such other terms and conditions subject to which such information is provided.

This Bid Document is not an agreement and is neither an offer nor invitation by the Purchaser to the prospective Bidder(s) or any other party hereunder. The purpose of this Bid Document is to provide the Bidder(s) with information to assist them in the formulation of their proposal submission. This Bid document does not purport to contain all the information Bidder(s) may require. This Bid document may not be appropriate for all bidders, and it is not possible for the Purchaser to consider particular needs of each Bidder. Each Bidder should conduct its own investigation and analysis, and should check the accuracy, reliability, and completeness of the information in this document and obtain independent advice from appropriate sources.

Information provided in this Bid Document to the Bidder(s) is on a wide range of matters, some of which may depend upon interpretation of law. The information given is not intended to be an exhaustive account of statutory requirements and should not be regarded as a complete or authoritative statement of law. The Purchaser, its employees and other associated agencies accept no responsibility for the accuracy or otherwise for any interpretation or opinion on law expressed herein.

This Bid document and ensuing bids; communications and Contracts would alone determine the legal and commercial relationship between the bidders/ contractors and the Purchaser. No other Government or Purchaser's document/ guidelines/Manuals including its Procurement Manual (which are for internal and official use of its officers), have any locus standi in such a relationship. These documents/guidelines/Manuals therefore should not be cited or referred in any legal or dispute resolution or grievance redressal proceedings.

The Purchaser, its employees and other associated agencies make no representation or warranty and shall have no liability to any person, including any Bidder under any law, statute, rules or regulations or tort, principles of restitution or unjust enrichment or otherwise for any loss, damages, cost or expense which may arise from or be incurred or suffered on account of anything contained in this Bid Document or otherwise, including the accuracy, adequacy, correctness, completeness or reliability of the Bid Document and any assessment, assumption, statement or information contained therein or deemed to form part of this Bid Document or arising in any way for participation in this Bid Stage.

The Purchaser, its employees and other associated agencies also accept no liability of any nature whether resulting from negligence or otherwise howsoever caused arising from reliance of any Bidder(s) upon the statements contained in this Bid Document.

The Purchaser may in its absolute discretion, but without being under any obligation to do so, update, amend or supplement the information, assessment or assumptions contained in this Bid Document.

The issue of this Bid Document does not imply that the Purchaser is bound to select Bidder(s) and the Purchaser reserves the right to reject all or any of the Bidders or Bids or to decide to drop the procurement process at any stage without assigning any reason.

The Bidder(s) shall bear all its costs associated with or relating to the preparation and submission of their Bids including but not limited to preparation, copying, postage, delivery fees, expenses associated with any



Tender Number: 6000017196

submission of samples, demonstrations or presentations which may be required by the Purchaser or any other costs incurred in connection with or relating to their Bids. All such costs and expenses will remain with the Bidder(s) and the Purchaser shall not be liable in any manner whatsoever for the same or for any other costs or other expenses incurred by a Bidder(s) in preparation or submission of the Bid, regardless of the conduct or outcome of the Bidding Process.

This disclaimer forms an integral part of the Bid document and shall supplement but not supplant the provision of the Bid Document.



Tender Number: 6000017196

SECTION I: NOTICE INVITING TENDER (NIT)

INDIA SECURITY PRESS

(A Unit of Security Printing and Minting Corporation of India Limited)

Wholly owned by Government of India

Nashik Road – 422 101 (Maharashtra) Tel No 00 91 253 2402200, Fax No 00 91 253 2462718

Website: www.spmcil.com, email: purchase.isp@spmCIL.com

Date: 10.02.2022

Tender No. 6000017196/113/SY-3-14(XF)2021-22

1. Sealed tenders are invited from eligible and qualified tenderers for supply of following goods and services:

Schedule No.	Brief Description of Goods/ services	Quantity (With unit)	Earnest Money (In Rupee)	Remark
1.	CORRUGATED BOXES IN THE SIZE OF 530 MM (L) X 400 MM (W) X 300 MM (H)	3,000 Nos.	Exempted. Please Refer Annexure-1	ITEM FALLS UNDER RESERVED/EXCLUSIVE LIST FOR PURCHASE FROM MSE/SSI.

Type of Tender (Two Bid/ PQB/ EOI/ RC/Development/Indigenization/ Disposal of Scrap/ Security Item etc):	Two Bid National Competitive Bidding (NCB)
Dates of sale of tender documents:	From 11.02.2022 to 15.03.2022 during office hours
Price of the tender document:	Nil
Place of sale of tender documents:	Purchase section, India Security Press, Nashik Road-422 101, Maharashtra, India
Closing date and time for receipt of tenders:	15.03.2022 up to 14:30 Hrs
Place of receipt of tenders:	Green Gate, India Security Press, Nashik Road-422 101, Maharashtra, India
Time and date of opening of tenders:	15:00 Hours on 15.03.2022
Place of opening of tenders:	Purchase Section, India Security Press, Nashik Road-422 101, Maharashtra, India
Nominated Person/ Designation to Receive Bulky Tenders (Clause 21.21.1 of GIT):	Jt. General Manager(HR), India Security Press, Nashik Road-422 101, Maharashtra, India

- Interested tenderers may obtain further information about this requirement from the above office selling the documents. They may also visit our website mentioned above for further details.
- Please note that SPMCIL reserves its right to grant Purchase preferences in accordance with Government of India's Public Procurement (Preference to Make in India) Order 2017 (as amended/ revised) and Public Procurement Policy for Micro and Small Enterprises (MSEs) Amendment Order, 2018 (as amended/ revised).
- Tenderer may also download the tender documents from the web site mentioned above and submit its tender by utilizing the downloaded document; the bidder must not make any changes to the contents of the documents, except for filling the required information. A certificate to this effect must be submitted by the bidder in the Tender Form (Section X).
- Tenderers shall ensure that their tenders, duly sealed and signed, complete in all respects as per instructions contained in the Tender Documents, are dropped on or before the closing date and time indicated in the Para 1



Tender Number: 6000017196

above in the tender box located at the address given below , failing which the tenders will be treated as late and rejected. Tenders may also be sent through post at the address as above. However, Purchaser will not be responsible for any postal lapses or delays in receipt of the documents. In case NIT/ SIT provide for uploading of bids to nominated eProcurement portal, bidders must upload their bids along with scanned copies as required enclosures (including proofs of cost of Tender Documents and EMD as applicable - unless an online payment gateway is provided in the instruction) as per instructions given in this regard. Original copies of such scanned uploaded required enclosures must reach in physical form within the date and place as provided in such instructions, otherwise their uploaded bid, would be declared as unresponsive.

6. Micro and Small Enterprises firms are exempted from submitting Tender Fees and Earnest Money Deposit. Please send the copy of valid registration certificate of Micro and Small Enterprises along with the bid/ quotation otherwise the offer will not be considered for above exemption.
7. Relaxation of norms fro Startups and Micro and Small Enterprises on 'Prior Experience', 'Prior Turnover' Criteria may be given subject to meeting of quality and technical specification as per Policy Circular No. 1(2)(1)/2016-MA dated 10/03/2016 issued by Govt. of India, Ministry of Micro, Small and Medium Enterprises, New Delhi.
8. Order No. P-45021/2/2017-B.E.-II dt:15/06/2017 for Public Procurement, Preference to Make in India (and Amendments thereof, if any) issued by Ministry of Commerce and Industry, Department of Industry and Internal Trade (Public Procurement Section), and Order No. 6/18/2019-PPD dt 23/07/2020 for prior registration on procurement from bidders from a country or countries on ground of Defense of India and national Security, issued by Ministry of Finance, Department of Expenditure (Public Procurement Division) will be applicable as per guidelines of Government of India.
9. As per Government of India guidelines, the subject item to be procured falls under the reserved/exclusive list of items for purchase from MSEs/SSI units Hence, only MSEs/SSI units can participate in this tender which is registered with NSIC/ Any other body specified by Ministry of MSME for the respective item mentioned in NIT. MSEs are also requested to indicate clearly in their offer if their company is owned by SC/ST/WOMEN proprietorship.
10. In the event of any of the above mentioned dates being declared as a holiday/ closed day for the purchase organisation, the tenders will be sold/ received/ opened on the next working day at the appointed time.
11. The Chief General Manager, ISP Nashik reserves the right to accept/reject/ cancel any or all tender document without assigning any reason thereof. Chief General Manager, ISP Nashik also reserves the right to accept the tender in whole or in part. Incomplete documents, not submitted in accordance with the directions issued, will be liable for rejection.
12. The tender documents are not transferable.

Jt. General Manager (Material)
For Chief General Manager,
India Security Press,
Nashik Road. Phone No 0253 2402219

Address for dropping the tender documents
Green Gate,
India Security Press,
Nashik Road-422 101, Maharashtra,



Tender Number: 6000017196

Section II: General Instructions to Tenderer (GIT)

PART I & II: GENERAL INSTRUCTIONS Applicable to all Types of Tenders:

Please refer the link to <https://spmCIL.com/uploaddocument/GIT/new.pdf> for further details.

GIT (Total pages: 61)

BIDDERS ARE REQUESTED TO DOWNLOAD 61 PAGES BY CLICKING THE ABOVE SAID LINK AND SUBMIT THE SAME DULY STAMPED AND SIGNED ALONG WITH TENDER DOCUMENT.



SECTION III: SPECIAL INSTRUCTIONS TO TENDERERS (SIT)

The following Special Instructions to Tenderers will apply for this purchase. These special instructions will modify/ substitute/ supplement the corresponding General Instructions to Tenderers (GIT) incorporated in Section II. The corresponding GIT clause numbers have also been indicated in the text below:
 In case of any conflict between the provision in the GIT and that in the SIT, the provision contained in the SIT shall prevail.(Clauses of GIT listed below include a possibility for variation in their provisions through SIT. There could be other clauses in SIT as deemed fit.)

Sr. No.	GIT Clause No.	Topic	Modify/ Substitute/ Supplement	SIT Provision
1	3	Eligible Tenderers		As applicable
2	4	Eligible Goods and Services (Origin of Goods)		As applicable
3	6.1	The tender documents includes:	Modify	SIT 1 (Mentioned below)
4	8	Prebid Conference		Not applicable
5	9	Time Limit for receiving request for clarification of Tender Documents		SIT 2 (Mentioned below)
6	10.1	The Technical bid to be submitted by Tenderer shall contain the following documents, duly filled in, as required		As applicable
7	11.2	Tender Currency		As applicable
8	12.1	Tender Prices		As applicable
9	12.6	GST details		As applicable
10	16.1 a) to c)	Documents Establishing Tenderer's Eligibility and Qualifications	Modify	As per Section IX: Qualification / Eligibility Criteria
11	18.4, 18.5	Earnest Money Deposit (EMD)	Modify	SIT 3 (Mentioned below)
12	19	Tender Validity	Modify	SIT 4 (Mentioned below)
13	20.4	Number of Copies of Tenders to be submitted		SIT 5 (Mentioned below)
14	20.8	Two Bid System		As applicable
15	21	Submission of Tender	Modify	SIT 6 (Mentioned below)
16	24	Opening of Tender & Evaluation Process	Modify	SIT 7 (Mentioned below)
17	52.3, 52.4, 52.5	Tenders involving purchaser's and pre-production samples	Modify	SIT 8 (Mentioned below)

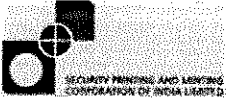

Tender Number: 6000017196

SIT 1:- The tender documents includes:- The tender documents includes:

1. Section I - Notice Inviting Tender (NIT)
2. Section II - General Instructions to Tenderers (GIT)
3. Section III - Special Instructions to Tenderers (SIT)
4. Section IV - General Conditions of Contract (GCC)
5. Section V - Special Conditions of Contract (SCC)
6. Section VI - List of Requirements
7. Section VII - Technical Specifications
8. Section VIII - Quality Control Requirements
9. Section IX - Qualification/ Eligibility Criteria
10. Section X - Tender Form
11. Section XI - Price Schedule
12. Section XII - Vendor Details
13. Section XIV: Manufacturer's Authorization Form
14. Section XV - Bank Guarantee Form for Performance Security
15. Section XVI - Contract Form
16. Section XVII: Letter of Authority for attending a Bid Opening
17. Section XVIII: Proforma of Bills for Payments
18. Section XIX: NEFT Mandate

SIT 2: Time Limit for receiving request for clarification of Tender Documents:- A tenderer requiring any clarification or elucidation on any issue of the tender document may take up the same with ISP Nashik in writing or by fax/ e-mail/ post. ISP Nashik will respond in writing to such request provided the same is received by ISP Nashik not later than **21 days prior** to the prescribed date of submission of tender.

SIT 3: Earnest Money Deposit (EMD): Exempted. However, **Bidder is requested to submit the duly stamped and Signed Annexure-I (Enclosed at the end of this Tender Document).**

SIT 4: Tender Validity:-

(i) The tenders shall remain valid for acceptance for a period of **120 days after the date of tender opening** prescribed in the tender document. Any tender valid for a shorter period shall be treated as unresponsive and rejected.

(ii) In exceptional cases, the tenderers may be requested by ISP Nashik to extend the validity of their tender upto a specified period. Such request(s) and response thereto shall be conveyed by surface mail or by fax/ e-mail followed by surface mail. The tenderers who agree to extend the tender validity, are to extend the same without any change or modification of their original tender.

(iii) In case the day upto which the tenders are to remain valid falls on/ subsequently declared a holiday or closed day for ISP Nashik, the tender validity should automatically be extended upto the next working day.

(iv) Compliance with the Clauses of this Tender Document: Tenderer must comply with all the clauses of this Tender Document. In case there are any deviations, these should be listed in a chart form without any ambiguity along with justification.



Tender Number: 6000017196

SIT 5: Number of Copies of Tenders to be Submitted: - Tenderer shall submit their tender in “Original” only

SIT 6: Submission of tender: Techno Commercial Bid and the Price Bid are to be submitted in Two Separate double sealed Envelopes on or before the due date of the submission of the tender as stated below otherwise tender/ bid / quotation shall be liable for rejection.

PART I : Techno-Commercial bid :- (First Envelope):

1. **Earnest Money Deposit:** Exempted. However, Bidders are requested to submit the Duly Stamped and Signed Annexure-1 (Enclosed at the end of Tender Documents). the attached Annexure-1 shall be treated as part of this Tender Documents. Annexure-1 of this Tender Document is to be printed on Bidder's Letter Head.
2. **Power of Attorney/ Authorization** with the seal of company indicating that authorized signatory is competent and legally authorized to submit the tender and/ or to enter into legally binding contract.
3. The eligibility criteria for the tender are given in **Section IX- Qualification/ Eligibility Criteria**. The bidder has to submit all the desired documents and relevant documentary proof in support of relevant clauses mentioned in Section IX: Qualification/ Eligibility Criteria. The Qualifying Criteria should be submitted in original.
4. The tenderer shall submit detailed techno-commercial offer as per Technical Specifications mentioned as per Section-VII and List of Requirement as per Section-VI of the tender document.
5. The tenderer has to submit sealed and signed tender document by authorized signatory of the tenderer as a token of acceptance of all section/ terms and conditions of this tender document (GIT, SIT, GCC & SCC, Quality Control Requirement, List of Requirement, Technical Specification, Tender form etc.)

Part-II: Price Bid (Second Envelope):

The tenderer shall quote their prices strictly as per the proforma given in Section-XI of the Tender document. No additional/ extra item with price shall be included other than that of Section XI.

NOTE:-

- i. Each envelope containing bids shall be super scribed as, Techno-commercial Bid and Price Bid separately as the case may be for “**CORRUGATED BOXES IN THE SIZE OF 530 MM (L) X 400 MM (W) X 300 MM (H)**”. The sealed envelopes shall be again put in another envelope and super scribed as tender for “**CORRUGATED BOXES IN THE SIZE OF 530 MM (L) X 400 MM (W) X 300 MM (H)**” due on 15:00 hrs. IST on 15.03.2022.
- ii. If the tender is not submitted as per above format, offer/ bid/ tender will be liable for rejection.
- iii. Late Tender shall not be accepted. Tenderer shall submit their offer only on prescribed form. Tenders by fax/ email shall not be accepted. Tender by Post/hand/courier received on or before the due date and time shall be accepted. Postal delay/ delay by courier services etc. shall not be condoned, what so ever reason may be.



Tender Number: 6000017196

SIT 7: Opening of Tender & Evaluation Process:

- 7.1 In the first instance, the **Techno-Commercial** part of Tender document will be opened and considered for the evaluation. These offers/ bid will be scrutinized and evaluated by the competent committee/ authority with reference to the parameters prescribed in the eligibility criteria (**Section IX**). The technical acceptance of the bids is on the basis of **Technical Specifications** offered by the bidders as per **Section -VII** Technical Specification and Section-VI List of Requirement of the tender document and acceptance of the terms and conditions as per GIT, SIT, GCC, SCC, other conditions of tender. **Conditional offers will be liable for rejection.**
- 7.2 In the second stage, the Price Bid of only Techno Commercially Qualified firm offers (as mentioned first stage) will be opened for further scrutiny and evaluation.

The intimation regarding opening of price bids shall be given to qualified tenderers to enable them to attend the technical and price bid opening, if they so desire.

- 7.3 **Price bid evaluation:** In the second stage, the price bid of only Techno Commercially Qualified firm will be opened for further scrutiny and evaluation. The price quoted shall be Compared on Total Price basis (FOR ISP Nashik Road), including all taxes, duties, packing and forwarding charges, freight, insurance, etc. The evaluation criteria for awarding the contract shall be to L1 bidder schedule mentioned in **Section XI Price Bid.**

SIT 8: Pre-Production Sample: In addition to the conditions mentioned in GIT Clause No. 52, the following shall also apply: Two (02) Nos. of sample boxes as a Pre-Production to be supplied within 15 days from the date of issue of Letter of Intent for approval at free of cost.

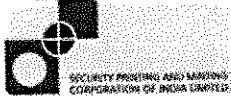

Tender Number: 6000017196

SECTION IV: GENERAL CONDITION OF CONTRACT (GCC)

Please refer the link <https://spmCIL.com/uploaddocument/GCC/new.pdf> for further details

GCC (Total pages: 36)

BIDDERS ARE REQUESTED TO DOWNLOAD 36 PAGES BY CLICKING THE ABOVE SAID LINK AND SUBMIT THE SAME DULY STAMPED AND SIGNED ALONG WITH TENDER DOCUMENT.



Tender Number: 6000017196

Section V: Special Conditions of Contract (SCC)

The following Special Conditions of Contract (SCC) will apply for this purchase. The corresponding clauses of General Conditions of Contract (GCC) relating to the SCC stipulations have also been incorporated below. These Special Conditions will modify/ substitute/ supplement the corresponding (GCC) clauses.

Whenever there is any conflict between the provision in the GCC and that in the SCC, the provision contained in the SCC shall prevail.

(Clauses of GCC listed below include a possibility for variation in their provisions through SCC. There could be other clauses in SCC as deemed fit)

S. No	GCC Clause No.	Topic	Modify/ Substitute/ Supplement	SCC Provision
1	6.1, 6.2, 6.3 & 6.5	Performance Bond/ Security	Modify	SCC 1 (Mentioned below)
2	8	Packing and Marking		As applicable
3	9	Inspection and Quality Control		As applicable
4	11.2	Transportation of Domestic Goods		SCC 2 (Mentioned below)
5	12.1 & 12.2	Insurance		As Applicable
6	14.1	Incidental Services		As Applicable
7	15	Distribution of Despatch Documents for clearance/ Receipt of Goods		SCC 3 (Mentioned below)
8	16.2, 16.4	Warrantee Clause		As Applicable
9	19.3	Option Clause		SCC 4 (Mentioned below)
10	20.1	Price Adjustment Clause		Not Applicable
11	21.	Taxes and Duties	Modify	SCC 5 (Mentioned below)
12	22	Terms and Mode of payments	Modify	SCC 6 (Mentioned below)
13	24.1	Quantum of LD		SCC 7 (Mentioned below)
14	25.1	Bank Guarantee and Insurance for Material Loaned to Contractor		Not Applicable
15	33.1	Resolution of Disputes		As applicable
16	36.3.2, 36.3.9	Disposal/ Sale of Scrap by Tender		Not Applicable

SCC-1: Performance Bond/ Security:

- (i) If value of contract is more than 2.5 lakhs the successful bidder has to submit Performance Bond/ Security equivalent to 3% of the order(s) value, valid for a period of 60 days beyond the completion of all contractual obligations by the supplier, including the warranty period, within 21 days from the date of issue of Letter of Intent/award of contract.
- (ii) The Performance security shall be denominated in Indian Rupees or in the currency of the contract and shall be in one of the following forms:
 - a) Account Payee Demand Draft or Fixed Deposit Receipt drawn on any commercial bank in India, in favour of ISP, unit of SPMCIL payable at Nashik.
 - b) Bank Guarantee issued by a commercial bank in India, in the prescribed form as provided in section XV of this document.

SCC 2:- Transportation of Goods: The transportation of goods to be procured will be done by the supplier on FOR ISP Basis. The total cost of the transportation should be indicated in the price bid of the item to be procured.



Tender Number: 6000017196

- SCC 3:- Distribution of Dispatch Documents for Clearance/Receipt of Goods:** The supplier shall send all the relevant dispatch documents well in time to ISP Nashik to enable ISP Nashik to clear or receive (as the case may be) the goods in terms of the contract.
- SCC 4:- Option Clause:** The purchaser reserve the right to increase the ordered quantity by 25% at any time, till final delivery date of the contract, by giving reasonable notice even though the quantity ordered initially has been supplied in full before the last date of the delivery period.
- SCC 5:- Taxes and Duties:-** Supplier shall be entirely responsible for all taxes, duties, fees, levies etc. incurred until delivery of the contracted goods to SPMCIL. If the tenderer fails to include taxes and duties as per law of the land in the tender, no claim thereof will be considered by purchaser at a later stage.
- SCC 6 :- Terms and Mode of payments:-** The payment term is 100% within 30 days after receipt of Materials, inspection and acceptance of goods by the purchaser and on production of all required documents by the supplier. The payment will be done through online only. Therefore, the suppliers have to produce all the bank details such as Name of Bank, Account No., IFSC Code No., MICR No. along with the Tender document. GST as applicable as per rules. TDS, if applicable will be deducted from the firms bill.
- SCC 7:- Quantum of LD:-** Subject to GCC clause 28, if the supplier fails to deliver any or all of the goods or fails to perform the services within the time frame(s) incorporated in the contract, ISP shall, without prejudice to other rights and remedies available to ISP under the contract, deduct from the contract price, as liquidated damages, a sum equivalent to the ½% percent (or any other percentage if prescribed in the SCC) of the delivered price of the delayed goods and/ or services for each week of delay or part thereof until actual delivery or performance, subject to a maximum deduction of the 10% (or any other percentage if prescribed in the SCC) of the delayed goods' or services' contract price(s). During the above-mentioned delayed period of supply and / or performance, the conditions incorporated under GCC sub-clause 23.4 above shall also apply. In all such cases GST would also be applicable on LD.



Tender Number: 6000017196

Section VI: List of Requirements

1.

Schedule No.	Brief description of goods and services (Related specifications etc. are in Section-VII)	HSN/SAC Code	Accounting unit	Quantity	Amount of Earnest Money (INR)	Place of Delivery for GST purpose
1)	CORRUGATED BOXES IN THE SIZE OF 530 MM (L) X 400 MM (W) X 300 MM (H) (As per section VII of tender)		Nos.	3,000	Exempted. However, Bidder is requested to submit the Duly Stamped and Signed Annexure-I (Enclosed at the end of this Tender Document).	India Security Press, Nashik

2.

(a)	Required Delivery Schedule	:	1. Pre-Production Sample: Two (02) Nos. of sample boxes as a Pre-Production to be supplied within 15 days from the date of issue of Letter of Intent for approval at free of cost. 2. Bulk Supply: After sample suitability, the delivery schedule will be as under. i) The total quantity is to be supplied in 03 equal quarterly installments i.e. 1000 Nos. of Boxes per quarter.
(b)	Required Terms of Delivery	:	FOR ISP, Nashik Basis.
(c)	Destination	:	India Security Press, Nashik Road-422 101. Maharashtra, India
(d)	Preferred mode of transportation	:	By Road.

1. All the copies of tenders shall be completed in all respects with all their attachments/enclosures duly numbered and signed on each and every page.
2. The total cost inclusive of all elements as cited above on FOR India Security Press, Nashik Road (Maharashtra), India, basis should be indicated clearly both in words and figures in the price bid.
3. Price bid should be submitted as per format in Section XI. Rate quoted should be on firm price basis. Vague offers like "GST as applicable" shall not be considered.

4. The Bidder has to submit the Check list as per Format given below along with the Techno-commercial Documents (First Envelope):



Tender Number: 6000017196

4. The Bidder has to submit the Check list as per Format given below along with the Techno-commercial Documents (**First Envelope**):

Sr. No.	Description	Submitted /Not Submitted	Page No.
1.	EMD (duly signed and sealed Annexure-I)		
2.	Documentary evidence towards Experience as per clause 1(A) of section IX.		
3.	Documentary evidence towards capability as per clause 1(B) of section IX.		
4.	Documentary evidence towards Financial data as per clause 1 (C) (i), (ii) & (iii) of section IX.		
5.	Copy of PAN & GST Registration.		
6.	valid registration certificate as MSE issued by NSIC, DGS&D or any authorized body by Ministry of MSME as per clause 1 (e) of section IX.		
7.	Undertakings/Declarations as per clause 2 (i), (ii) & (iii) of section IX.		
8.	Documentary evidence towards Manufacturer's authorization letter as per section XIV, if applicable		
9.	Power of Attorney/ Authorization with the seal of company indicating that authorized signatory is competent and legally authorized to submit the tender and/ or to enter into legally binding contract.		
10.	All pages of the tender documents (including GIT, GCC, SIT, SCC, List of requirements, Technical specification, quality requirements, etc.) duly signed and stamped by the Authorized signatory of the bidder.		
11.	Adherence to the Technical Specification as per Section VII on Bidder's Letter Head and other required information.		
12.	Adherence to the Quality Control Requirements as per Section VIII on Bidder's Letter Head.		
13.	Adherence to the Delivery Schedule as per Section VI on Bidder's Letter Head.		

The Bidder has to submit the Check list as per Format given below along with the Price Bid (**Second Envelope**):

Sr. No.	Description	Submitted /Not Submitted	Page No.
1.	Duly filled Section XI: Price bid		

Section VII: Technical Specifications

SPECIFICATION OF CORRUGATED BOX

Broad fluted 5 Ply Corrugated Box (Collapsible), capable of carrying loads of 50 Kgs, strong enough to resist transportation hazards are required as per attached sketch.

A) Size of Box (Internal Dimension in mm) : **Type - XF** : A-530, B-400, C-300, D-250, E-400, F-530 & G-125 (As per attached Sketch ; Tolerance +10 mm for these internal dimensions.)

B) Characteristics of Corrugated Box

- 1) 5 Ply Broad flute, flute direction should be vertical
- 2) Paper to be used: Liner Craft paper 'A' grade 250 + 10 GSM
- 3) Bursting Strength of the board: Min 25 kg/cm²
- 4) Adhesive to be used: Very Strong, best quality of low moisture absorbency.
- 5) Compression strength; 500 Kgs (Empty Box)
- 6) Cobb Valve: All papers must be of low Cobb (below 30)
- 7) Box outer and inner surface should be water resistant but outer surface should be capable of holding stencil ink (Solvent: turpentine)
- 8) To be printed with Code Mark identification (Code mark **XXX** in font size **XX** mm will be provided to successful bidder)
- 9) General Workmanship & Finish shall be good throughout.

C) Sample: -

A Sample of 2 Boxes are to be submitted for approval, before bulk Supply. Sample must be submitted within 15 days of issue of Supply Order.

D) Testing:

Testing of GSM will be done as per IS 7063 (Part IV)-1976. Testing for bursting strength of the board and water absorption of the outer surface will be done as per IS 2771 (Part I)-1977.

XF- A-530/B-400/C-300/D-250/E-400/F-330/G-125
 Types: A-500, B-110, C-150, D-200, E-410, F-500 & G-00.
 As per attached Sketch; Tolerance + (± 0 mm for these dimensions)

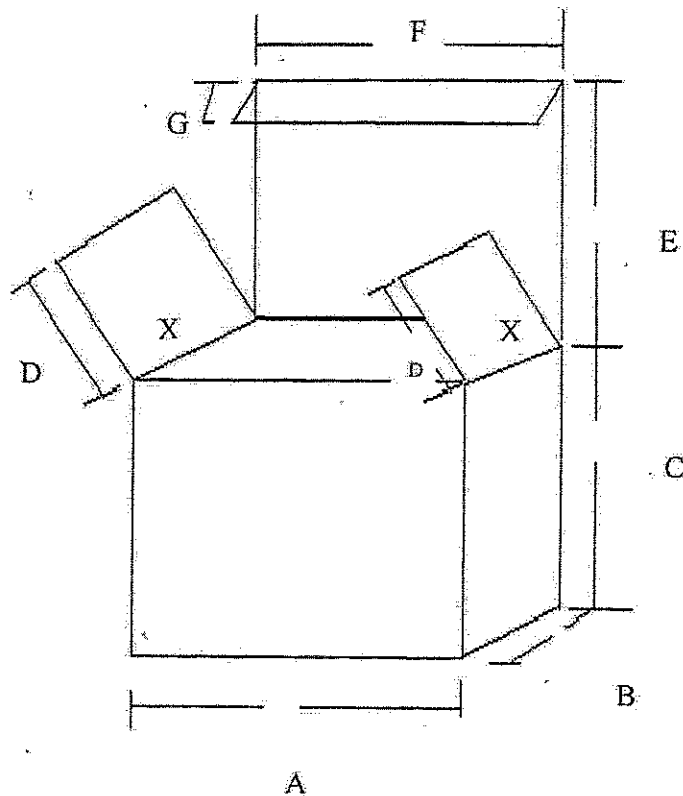

1. Top and Bottom flap will have the same configuration.
2. The internal size of Corrugated Box will be L x W x H. The above detailed Sizes are shown for guidance only. The actual Sizes may vary to accommodate the thickness of Corrugated Sheet and ease of Opening/Closing Flaps 'X' are to be less by 5 mm both sides for the width for easy inserting.
3. 15 mm width slots to be provided for holding of iron Strips/Nylon Straps.

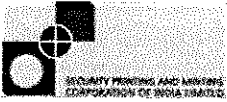

Tender Number: 6000017196

Section VIII: Quality Control Requirements

The material supplied by the successful bidder will be accepted on manufacturers test certificate from its own laboratory or a laboratory of repute conforming to all parameters as per specification as stated above. The purchaser reserves the right to get the material supplied tested from in-house laboratory or any other laboratory of repute and in case the material is found not meeting the specification, the purchaser shall be entitled to cancel the contract, and if so desired, purchase or otherwise the purchase of the stores at the risk and cost of the contractor.



Section IX: Qualification / Eligibility Criteria

1. The Bidder firm should meet following eligibility criteria to qualify in the Techno Commercial bid:

(A) Experience and past performance:

The bidder should have manufactured and supplied at least 1200 Nos. of similar type of "Corrugated Boxes" in any one of the last five years ending on "31 March 2021".

Note: The 'Experience and Past experience criteria' is exempted for Startups and Micro and Small Enterprises.

(B) Capability - Equipment & manufacturing Facilities: -

1) The bidder must have an annual capacity to manufacture and supply at least 1200 Nos. of "Corrugated Boxes"

2) The bidder has to submit the following details along with the bid:

- i) Name of the machine utilized to supply the quoted product.
- ii) The number of machines being utilized for the production and the capacity of each machine.
- iii) Total Annual capacity of Manufacturer
- iv) Supply orders in hand and proportionate capacity to supply quoted amount

Note: At the discretion of the purchaser, the Capacity / Capability Assessment / Verification of bidder / manufacturer firm(s) might be undertaken by Committee or through a third party Technical Consultancy / Inspection agencies to ensure that the firm is/are identified and capable to supply the item/material/product as required.

(C) Financial Standing:

1) The average annual financial turnover of the bidder during the last three years, ending on '31.03.2021', should be at least Rs. 1,83,600/- as per the annual report (audited balance sheet and profit & loss account) of the relevant period, duly authenticated by a Chartered Accountant/Cost Accountant in India or equivalent in relevant countries.

Note: The 'Average Annual Turnover criteria' is exempted for Startups and Micro and Small Enterprises.

2) The bidder should not have suffered any financial loss for more than one year during the last three years, ending on '31.03.2021'.

- (i) The net worth of the Bidder should not be negative on '31.03.2021' and also
- (ii) Should not have eroded by more than 30% in the last three years, ending on '31.03.2021'.

2. Bidder firm shall submit the copy of PAN & GST Registration Certificate.

3. **Certificate of MSE:** The firm must have a valid registration certificate as MSE issued by NSIC, DGS&D or any authorized body by Ministry of MSME for manufacturing of the tendered item and the same shall be submitted by the firm along with the tender/bid.

4. Other Eligibility requirements for the Bidders:

(a) The application should be submitted in English Language. The authenticated copies of the documents in support of the applicant's claims must be submitted in English language.

(b) The bidder shall indicate/ certify that authorized signatory is competent and legally authorized to submit the tender and/ or to enter into legally binding contract.



Tender Number: 6000017196

- (c) **Blacklisting:** The bidder firm should submit declaration that the firm has not been blacklisted/ debarred by any government agency / Public Sector Unit/ Reputed organization.
- (d) **Agree to withdraw all deviations:** The bidder firm should submit declaration that “We agree to withdraw all the deviations, if any, unconditionally and accept all the terms and conditions of the tender document including the technical specifications”.

Note:

- 1) **Relaxation of Norms for Micro & Small Enterprises (MSEs) and Startups:** Pre-Qualification Criteria in respect to Prior Turnover and Prior Experience may be relaxed for MSEs and Startups as per GoI guidelines subject to meeting of Quality and Technical Specifications. The MSEs and Startups shall submit the valid Certificate issued by Competent Authority such as NSIC, DIC, KVIC, Khadi and Village Industries Board, Coir Board, Directorate of Handicraft and Handloom, Udyog Aadhar Acknowledgment/Udyog Aadhar Memorandum issued by Ministry of MSME, Any other body specified by Ministry of MSME (MoMSME) for MSEs and Certificate of Recognition issued by Department of Industrial Policy and Promotions (DIPP), Ministry of Commerce & Industry, Govt. of India for Startups subject to meeting extant & relevant guidelines of Government of India.
- 2) All experience, past performance and capacity/ capability related/ data should be certified by the authorized signatory of the bidder firm. The bidder should submit documentary evidence regarding the capability/capacity.
- 3) Decision on Finalization of tender will be taken based on the documents submitted along with the tender. All documents must be submitted as per tender requirement failing which offers will be liable for rejection and no further correspondence will be made/ entertained for clarification after opening of the tender.
- 4) All the pages submitted are to be required and sealed & signed by Authorised Signatory failing which tender shall be treated as unresponsive.

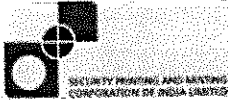

Tender Number: 6000017196

Section X: Tender Form

Date.....

To

.....
.....
.....

(complete address of SPMCIL)

Ref: Your Tender document No. dated

We, the undersigned have examined the above-mentioned tender enquiry document, including amendment No. -----, dated ----- (if any), the receipt of which is hereby confirmed. We now offer to supply and deliver..... (description of goods and services) in conformity with your above referred document for the sum shown in the price schedule(s), attached herewith and made part of this tender. If our tender is accepted, we undertake to supply the goods and perform the services as mentioned above, in accordance with the delivery schedule specified in the List of Requirements.

We further confirm that, if our tender is accepted, we shall provide you with a performance security of required amount in an acceptable form in terms of GCC clause 6, read with modification, if any, in Section V - "Special Conditions of Contract", for due performance of the contract.

We agree to keep our tender valid for acceptance for a period upto -----, as required in the GIT clause19, read with modification, if any in Section-III - "Special Instructions to Tenderers" or for subsequently extended period, if any, agreed to by us. We also accordingly confirm to abide by this tender upto the aforesaid period and this tender may be accepted any time before the expiry of the aforesaid period. We further confirm that, until a formal contract is executed, this tender read with your written acceptance thereof within the aforesaid period shall constitute a binding contract between us.

We confirm that in case of downloaded Tender Document, we have not changed/ edited its contents. We realise that in case any such change is noticed at any stage including after the award of contract, we would be liable to action under clause 44 of the GIT.

We further understand that you are not bound to accept the lowest or any tender you may receive against your above-referred tender enquiry. We also solemnly declare as under:

1. MSMEs Status:

Having read and understood the Public Procurement Policy for Micro and Small Enterprises (MSEs) Order, 2012 (as amended and revised till date), and solemnly declare the following:

- (a) Company /Partnership Firm /Proprietary Concern / Society/Trust / NGO/Others (Please Specify):.....
- (b) Micro/ Small / Medium Enterprise/ SSI/ Govt. Deptt. / PSU/ Others:....
- (c) Name of MSME Registering Body (NSIC/ DIC/ KVIC/KVIB etc.):.....
- (d) MSME Registration no. (with copy of registration):.....
- (e) Udyog Aadhaar Memorandum no.....
- (f) Whether Proprietor/ Partner belongs to SC/ ST or Women category.
(Please specify names and percentage of shares held by SC/ST Partners):.....

2. Make in India Status:

Having read and understood the Public Procurement (Preference to Make in India PPP_MII) Order, 2017 (as amended and revised till date) and related notifications from the relevant Nodal Ministry/ Department, and solemnly declare the following:

- (a) Self-Certification for category of supplier:
 - Class-I Local Supplier/
 - Class-II Local Supplier/

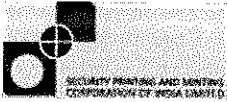

Tender Number: 6000017196

- Non-Local Supplier.

(b) We also declare that

- There is no country whose bidders have been notified as ineligible on reciprocal basis under this order for offered product, or
- We do not belong to any Country whose bidders are notified as ineligible on reciprocal basis under this order.

3. Restrictions on procurement from bidders from a country or countries, or a class of countries under Rule 144 (xi) of the General Financial Rules 2017

Having read and understood the Order (Public Procurement No. 1) issued vide F.No.6/18/2019-PPD dated 23rd July 2020 (and its amendments if any) by Department of Expenditure, Ministry of Finance under the above provision and solemnly declare the following:

- We do not belong to any Country whose bidders are notified as ineligible under this order

4. Debarment Status: Please state whether business dealings with you currently stand suspended/ banned by any Ministry/ Deptts. of Government of India or by any State Govt:

- Yes (with period of Ban)
- No, We, solemnly declare that neither we nor any of our affiliates or subsidiaries – including subcontractors or suppliers for any part of the contract – do not stand declared ineligible/ blacklisted/ banned/ debarred by any Government Agency anywhere in the world, for participating in its tenders, under that country’s laws or official regulations.

5. Penalties for false or misleading declarations: I/we hereby confirm that the particulars given above are correct and complete and also undertake to advise any future changes to the above details. We understood that any wrong or misleading self-declaration by us would be violation of code of Ethics and would attract penalties as mentioned in this tender document, including debarment.

.....
(Signature with date)

.....
(Name and designation)

Duly authorized to sign tender for and on behalf of

.....
.....

Tender Number: 6000017196

Section XI: Price Schedule

To,
Chief General Manager
India Security Press, Nashik Road

OFFER FORM for Tender No.....Date of Opening.....Time.....Hours
We.....hereby certify that we are established firm of manufacturers/authorized agents of M/s.with factories atwhich are fitted with modern equipment and where the production methods, quality control and testing of all materials and parts manufactured or used by us are open to inspection by the representative of(Name of Purchaser). We hereby offer to supply the following items at the prices indicated below:-

Schedule No.	Description	Specification	Unit	Qty	Total Price per unit (In Indian Rupees) See table below for Break-up of Price	Total Value of offer (In Indian Rupees)	Terms of Payments	Delivery Period	Gross weight and dimensions of package per unit
1	2	3	4	5	6=J	7=6X5	8	9	10
Corrugated Boxes in the size of 530 MM (L) X 400 MM (W) X 300 MM (H).									
1.	Corrugated Boxes in the size of 530 MM (L) X 400 MM (W) X 300 MM (H).	As per Section VII	Nos.	3,000			As per Section V: SCC 3 of Tender document	As per Section VI: 2 (a)	

Break-up of Price in Column - 6 (In Indian Rupees)

Ex-Factory Price after considering input GST credit available to vendor	Name of Manufacturer/OEM	Country of Origin	HSN/SAC Code	GST % (incl GST Cess, if any) with Break-up of CGST/STGST/UTGST/IGST	Per unit GST Total	Packing & Forwarding in details	F.O.R. Station of Dispatch Price	Freight (& Insurance charges) up to destination	FOR Destination on Price (per Unit)
A	B	C	D	E	F=A*E/100	G	H=A+F+G	I	J=H+I
	NA	NA							



Tender Number: 6000017196

1. Scope of Supply: (Cost break-up of the quoted cost, showing inter-alia costs of all the concomitant Installation/Commissioning/Training/Technical Support/Incidental Services/Software/accessories, considered necessary to make the proposal self-contained and complete must be indicated here.)
2. Taxation Details:-
 - a) PAN Number
 - b) Type of GST Registration (Registered, Unregistered, Composition, SEZ, RCM etc)
 - c) GSTIN Number
 - d) Registered Address as per GST Registration and Place of Delivery for GST Purpose.
 - e) Contract Names, Nos & email IDs for GST matters (Please mention primary and secondary contracts)
3. It is hereby certified that we have understood the General and Special Instructions to Tenderers (GIT and SIT), and also the General and Special Conditions of Contract (GCC and SCC) attached to the tender and have thoroughly examined specifications/Quality Control Requirement and other stipulations in Section VII & VIII required and out offer is to supply stores strictly in accordance with the requirements and according to the terms of the tender. We agree to abide solely by the General and Special Conditions of Contract and other conditions of the tender in accordance with the tender documents if the contract is awarded to us.
4. We hereby offer to supply the stores detailed above or such portion thereof, as you may specify in the acceptance of tender at the price quoted and agree to hold this offer open for acceptance for a period ofdays from the date of opening of tenders (i.e. upto.....), We shall be bound by the communication of acceptance dispatched within the prescribe time.
5. Earnests Money/Bid Guarantee for an amount equal tois enclosed in form of(form and reference number, date) as per the Tender documents.
Dated.....

Signature and Seal of Manufacturer/Bidder

Note:-

1. The Bidder may prepare their own offer forms as per this proforma.
2. No change in the proforma is permissible.
3. No erasures or alternations in the text of the offer are permitted. Any correction made in the offer shall be initialled by the bidder.
4. Figures in Columns 5 to 7 (both inclusive) and in Break-up of price in column 6, should be in both figures and words.
5. This Section should not bring in any new Technical Parameter that has not been mentioned in the Technical Bid.



Section XII: Vendor Details

The tenderer should furnish specific details mentioned below. In case a question/ issue does not apply to a tenderer, the same should be answered with the remark "not applicable".

Wherever necessary and applicable, the tenderer shall enclose certified copy as documentary proof/ evidence to substantiate the corresponding statement.

In case a tenderer furnishes a wrong or misleading answer against any of the under mentioned question/ issues, its tender will be liable to be ignored.

1. Vendor/ Contractor particulars:

- (a) Name of the Company:.....
- (b) Corporate Identity No. (CIN):
- (c) Registration if any with SPMCIL:
- (d) Complete Postal Address:
- (e) Pin code/ ZIP code:
- (f) Telephone nos. (with country/area codes):
- (g) Fax No.: (with country/area codes):
- (h) Cell phone Nos.: (with country/area codes):
- (i) Contact persons /Designation:
- (j) Email IDs:

2. Taxation Details:

- (a) PAN number:
- (b) Type of GST Registration (Registered, Unregistered, Composition, SEZ, RCM etc.):
- (c) GSTIN number:
- (d) Registered Address as per GST registration and Place of Delivery for GST Purpose:
- (e) Contact Names, Nos. & email IDs for GST matters (Please mention primary and secondary contacts):
.....

We solemnly declare that our GST rating on the GST portal / Govt. official website is NOT negative / blacklisted during the last three financial years.

.....
(Signature with date)

.....
(Full name, designation & address of the person duly authorized sign on behalf of the tenderer)
For and on behalf of

.....
(Name, address, and stamp of the tendering firm)



Tender Number: 6000017196

Section XIV: Manufacturer's Authorization Form

To
Chief General Manager
India Security Press,
Nashik Road :- 422101

Dear Sirs,

Ref. Your Tender document No....., dated

We,, who are proven and reputable manufacturers of (name and description of the goods offered in the tender) having factories at....., hereby authorise Messrs..... (name and address of the agent) to submit a tender, process the same further and enter into a contract with you against your requirement as contained in the above referred tender enquiry documents for the above goods manufactured by us.

We further confirm that no supplier or firm or individual other than Messrs. (name and address of the above agent) is authorized to submit a tender, process the same further and enter into a contract with you against your requirement as contained in the above referred tender enquiry documents for the above goods manufactured by us.

We also hereby extend our full warranty, as applicable as per clause 16 of the General Conditions of Contract read with modification, if any, in the Special Conditions of Contract for the goods and services offered for supply by the above firm against this tender document.

Yours faithfully,

.....
.....

[Signature with date, name, and designation]

for and on behalf of Messrs.....

[Name & address of the manufacturers]

Note: This letter of authorisation should be on the letter head of the manufacturing firm and should be signed by a person competent and having the power of attorney to legally bind the manufacturer.

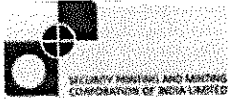

Tender Number: 6000017196

Section XV: Bank Guarantee Form for Performance Security

**PROFORMA OF BANK GUARANTEE FOR CONTRACT PERFORMANCE GUARANTEE BOND
(ON BANK'S LETTERHEAD WITH ADHESIVE STAMP)**

Ref Date
Bank Guarantee No
To,

(Insert Name & Address of the Purchaser)

Dear Sir,

1. Against contract vide Notification for Award of the Tender No dated covering supply of (hereinafter called the 'contract') entered into between the **(insert name of Purchaser)** (herein after called as the Purchaser) and M/s. (here in after called the 'Contractor'), this is to certify that, at the request of the Contractor, we **(name of the bank)**, are holding in trust in favour of the Purchaser, the amount of **(write the sum here in words)**, to indemnify and keep indemnified the Purchaser, against any loss or damage that may be caused to, or suffered by the Purchaser, by reason of any breach by the Contractor of any of the terms and conditions of the said contract and/or in the performance thereof. We agree that the decision of the Purchaser, whether any breach of any of the terms and conditions of the said contract and/or in the performance thereof has been committed by the Contractor; and the amount of loss or damage that has been caused or suffered by the Purchaser, shall be final and binding on us, and the amount of the said loss or damage shall be paid by us, forthwith on demand and without demur to the Purchaser.
2. We **(name of the bank)**, further agree that, the guarantee herein contained, shall remain in full force and effect, for sixty days after the complete conclusion of the contractual obligations to the complete satisfaction of both the BIDDER and the BUYER, including warranty period whichever is later, i.e. till, (hereinafter called the 'said date') and that if any claim accrues or arises against us **(name of the bank)**, by virtue of this guarantee before the said date, the same shall be enforceable against us **(name of the bank)**, notwithstanding the fact that the same is enforced within six months after the said date, provided that notice of any such claim has been given to us **(name of the bank)**, by the Purchaser, before the said date. Payment under this bond of guarantee shall be made promptly, upon our receipt of notice to that effect, from the Purchaser.
3. It is fully understood that this guarantee is effective from the date of the said contract and that we **(name of the bank)**, undertake not to revoke this guarantee during its currency, without the consent in writing of the Purchaser.
4. We undertake to pay to the Purchaser, any money so demanded, notwithstanding any dispute or disputes raised by the Contractor, in any suit or proceeding pending before any Court or Tribunal, relating thereto, our liability under this present, being absolute and unequivocal. The payments so made by us under this bond, shall be a valid discharge of our liability for payment thereunder, and the Contractor shall have no claim against us, for making such payments.
5. We **(name of the bank)**, further agree that the Purchaser shall have the fullest liberty, without affecting in any manner our obligations hereunder, to vary any of the terms and conditions of the said contract, or to extend time of performance by the Contractor, from time to time, or to postpone for any time or form, time to time, any of the powers exercisable by the Purchaser, against the said Contractor and to for bear or enforce any of the terms and conditions relating to the said contracts and we **(name of the bank)**, shall not be released from our liability under this guarantee, by reason of any such variation or extension being granted to the said Contractor, or for any forbearance and/or omission on the part of the Purchaser, or any indulgence by the Purchaser towards the said Contractor, or by any other matter or thing whatsoever, which under the law relating to sureties, would, but for this provision, have the effect of so releasing us from our liability under this guarantee.
6. This guarantee will not be discharged due to the change in the constitution of the Bank or the Contractor.

Date
Place

Signature
(Printed Name)
(Designation)

Witnesses

(Bank's Common Seal)



Tender Number: 6000017196

Section XVI: Contract Form

(Address of SPMCIL's office issuing the contract)

Contract No..... dated.....

This is in continuation to this office' Notification of Award No..... dated

1. Name & address of the Supplier:

2. SPMCIL's Tender document No..... dated..... and subsequent Amendment No....., dated..... (If any), issued by SPMCIL

3. Supplier's Tender No..... dated..... and subsequent communication(s) No..... dated, (If any), exchanged between the supplier and SPMCIL in connection with this tender.

4. In addition to this Contract Form, the following documents etc, which are included in the documents mentioned under paragraphs 2 and 3 above, shall also be deemed to form and be read and construed as part of this contract:

- (i) General Conditions of Contract;
(ii) Special Conditions of Contract;
(iii) List of Requirements;
(iv) Technical Specifications;
(v) Quality Control Requirements;
(vi) Tender Form furnished by the supplier;
(vii) Price Schedule(s) furnished by the supplier in its tender;
(viii) Manufacturers' Authorisation Form (if applicable for this tender);
(ix) SPMCIL's Notification of Award

Note: The words and expressions used in this contract shall have the same meanings as are respectively assigned to them in the conditions of contract referred to above. Further, the definitions and abbreviations incorporated under Section - V - 'General Conditions of Contract' of SPMCIL's Tender document shall also apply to this contract.

5. Some terms, conditions, stipulations etc. out of the above-referred documents are reproduced below for ready reference:

(i) Brief particulars of the goods and services which shall be supplied/ provided by the supplier are as under:

Table with 6 columns: Schedule No., Brief description of goods/services, Accounting unit, Quantity to be supplied, Unit Price (in Rs.), Total price

Any other additional services (if applicable) and cost there of:

Total value (in figure) _____ (In words) _____

- (ii) Delivery schedule
(iii) Details of Performance Security
(iv) Quality Control
(a) Mode(s), stage(s), and place(s) of conducting inspections and tests.
(b) Designation and address of SPMCIL's inspecting officer
(v) Destination and despatch instructions
(vi) Consignee, including port consignee, if any
(vii) Warranty clause
(viii) Payment terms
(ix) Paying authority

(Signature, name, and address of SPMCIL's authorized official)

For and on behalf of.....

Received and accepted this contract

(Signature, name, and address of the supplier's executive duly authorized to sign on behalf of the supplier)

For and on behalf of

(Name and address of the supplier)

(Seal of the supplier)

Date:

Place:



Tender Number: 6000017196

**Section XVII: Letter of Authority for attending a
Pre-bid Conference/ Bid Opening**

The General Manager
Unit Address

Subject: Authorization for attending bid opening on _____ (date) in the Tender of
_____.

Following persons are hereby authorized to attend the bid opening for the tender mentioned above on behalf of _____ (Bidder) in order of preference given below.

Order of Preference	Name	Specimen Signatures
I.		
II.		
Alternate Representative		
Signatures of bidder or Officer authorized to sign the bid Documents on behalf of the bidder.		

Note:

1. Maximum of two representatives will be permitted to attend pre-bid conference/ bid opening. In cases where it is restricted to one, first named representative will be allowed to attend. Alternate representative will be permitted when regular representatives are not able to attend.
2. In case of pre-bid conference, self-attested copy of proof of purchase of Bid documents, in the name of the bidder must be enclosed with this authorization, without which entry would be refused. Bid documents would be available for sale at the site also.
3. Permission for entry to the hall where even is held may be refused in case authorization as prescribed above is not produced.



Tender Number: 6000017196

Section XVIII: Proforma of Bills for Payments

(Refer Clause 22.6 of GCC)

Name and Address of the Firm.....

Bill No.....

Dated.....

Purchase order.....No.....Dated.....

Name and address of the consignee.....

S. No	Authority for purchase	Description of Stores	Number or quantity	Rate Rs. P.	Price per Rs. P.	Amount
Total						

1. GST/ CGST/ SGST/ UTGST/ IGST Amount

2. Freight (if applicable)

3. Excise Duty (if applicable)

4. Packing and Forwarding charges (if applicable)

5. Others (Please specify)

6. PVC Amount (with calculation sheet enclosed)

7. (-) deduction/Discount

8. Net amount payable (in words Rs.)

Dispatch detail RR No. other proof of despatch.....

Dated.....(enclosed)

Inspection Certificate No.....Dated.....(enclosed)

Place and Date

Received Rs.....

Rupees).....

We solemnly certify that:

a. Goods and Services Tax (GST) charged on this Bill is not more than what is payable under the provision of the relevant Act or the Rules made there under.

b. Goods on which GST has been charged have not been exempted under the GST Act or the rules made there under and the charges on account of GST on these goods are correct under the provisions of that Act or the Rules made there under.

c. We are registered with above indicated GSTIN as dealer in the State where in their Billing address is located for the purpose of GST.

d. This bill form / invoice is not a replacement for the GST invoice. The proper GST invoice as per requirements of GST rules has been sent to the Purchaser as and when deliveries are made to the consignee.

e. that the payment being claimed is strictly in terms of the contract and all the obligations on the part of the supplier for claiming that payment has been fulfilled as required under the contract.

Revenue stamp

Signature and of Stamp Supplier

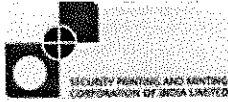

Tender Number: 6000017196

Section XIX: NEFT Mandate

(Refer clause 22.2 of GCC)

From: M/s. Date:

To:

(Insert Name and Address of Purchaser's Paying Authority as per NIT Clause 1)

Sub: NEFT payments

We refer to RBI's NEFT scheme. Our mandate SPMCIL for making payments to us through the above scheme to our under noted account.

NATIONAL ELECTRONIC FUNDS TRANSFER MANDATE FORM

1	Name of City	
2	Bank Code No.	
3	Branch Code No.	
4	Bank's Name	
5	Branch Address	
6	Branch Telephone / Fax No.	
7	Supplier's Account No.	
8	Type of Account	
9	IFSC code for NEFT	
10	IFSC code for RTGS	
11	Supplier's name as per Account	
12	MICR Code No.	

In Lieu of Bank Certificate to be obtained as under, please attach a bank cancelled cheque or photocopy of a cheque or front page of your bank passbook issued by your bank for verification of the above particulars.

I hereby declare that the particulars given above are correct and complete. If the transaction is delayed or not effected at all for reasons of incomplete or incorrect information, I would not hold the user institution responsible. I have read the option intimation letter and agree to discharge responsibility expected of me as a participant under the scheme.

Date

Signature of the Customer

Certified that the above particulars are correct as per our record.

Stamp and
Signature of authorized
official of the bank



Tender Number: 6000017196

Annexure-I

Bid Security Declaration Format
(To be printed on letter head of bidder)

Date:

To,
The Chief General Manager
India Security Press
Nashik Road

Sub: Bid Security Declaration-Reg.

Ref: 1. Tender No. _____ Dtd: _____

2. Bidder's offer no. _____ Dtd: _____

I, _____ (Name of authorized signatories), on behalf of
M/s. _____ (Bidder's name and address), duly
authorized to sign the tender document and enter into contract, if awarded, herewith accept that if the
bidder withdraw (or) modify our bid during period of validity, etc, the bidder will be
suspended/debarred/blacklisted for a period of one year / two years from the due date of the tender.

(Signature of Authorized Signatory)

Designation:

Name of Bidder:

Seal: